



FACA-601-ISE

Fully Automatic Chemistry Analyzer



Labomed introduces an automatic biochemistry analyzer with varying testing capacities. FACA-601 conducts 760 tests/hr with True Random Access .

Features

- *Random Access and Direct Reading System.*
- *Automatic Washing System for Both Sample and Reagent Probe.*
- *Liquid Level Detection and Collision Protection for Both Sample and Reagent Probe.*
- *Reliable Cooling System for Reagent Chamber.*
- *Works with Windows XP and Windows 7*
- *Powerful Reaction Cuvette Washing System.*
- *User-Friendly Interface.*
- *ISE module and barcode scanner (optional)*
- *Enzyme Kinetic GPT and GOT testing*
- *QC control function, based on Levy-Jennings chart analysis*

Labomed, Inc. is certified by ISO 9001-2013, has CE Conformity and is FDA Licensed

Accessories

40-type Reagent bottle 1	(40ml)	100pcs
Reagent bottle 2	(15ml)	100pcs
Cuvette	(20 holes)	8pcs
Detect probe		1 set
Sample cup		1000pcs
Sample probe		2pcs
USB cable		1pc
USB extension cable		1pc
Power cable		1pc
Com cable		1pc
Ground cable		1pc
Sensor		2pcs
Tube		1 set
Fixed buckle		2 sets
Tool		1 set
Fuse		4pcs
Connector (Φ8) and its nut		2pcs
Connector(Φ4) and its nut		1pc
Lamp with holder (12V/20W)		1 set
User manual		1pc
Operation software CD		1pc
PCI-E Card		1 set
Seal ring		3pcs
Detergent alarm needle		1pc



1 Reagent Tray

40 reagent positions for FACA-301 and FACA-261
 80 reagent positions for FACA-401
 Cooling system may work independently for 24 hours.

2 Sample Tray

60 sample positions for FACA-301 and FACA-261
 88 sample positions for FACA-401

3 Cuvette

Either high quality UV-transmitted plastic cuvettes or quartz glass cuvettes available.

4 Independent Mixer

1 mixer for FACA-301 and FACA-261
 2 mixers for FACA-401

5 Sample probe/ Reagent probe

1 sample probe and 1 reagent probe for FACA-301
 1 sample probe and 2 reagent probes for FACA-401
 Only 1 sample / reagent probe for FACA-261

6 ELE Module

ELE module available on request.

Cuvette Washing Station

8 channels automatic washing station.

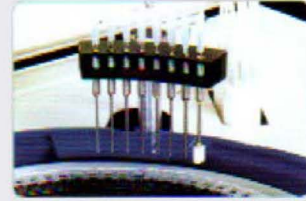

Independent Mixer

Independent mixer ensuring quick and complete reaction.



Reaction Cuvette

High quality UV-transmitted plastic cuvettes, or quartz glass cuvette (optional).



Sample Probe / Reagent Probe

With liquid level sensor, anti-collision sensor and automatic cleaning function.



Reagent Bottle

More convenient and economical ready to use reagent kits.



Reagent Tray

With cooling reagent chamber.

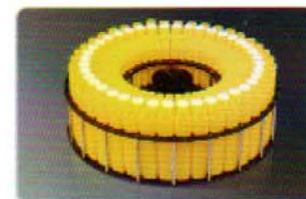

Software



User-Friendly Interface
Compatible with Windows XP, Vista or Windows 7

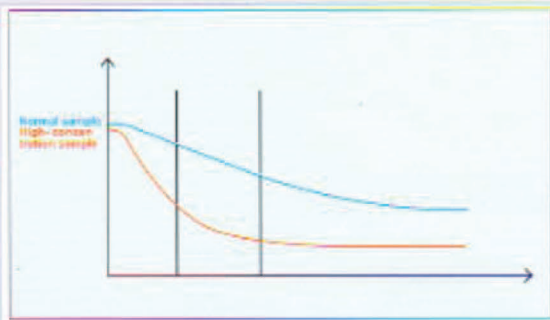

Variable reading function

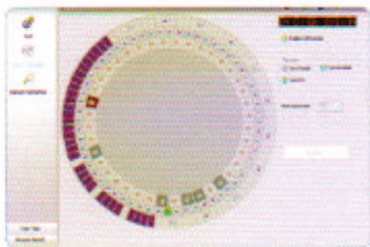

Carry Over Control Function

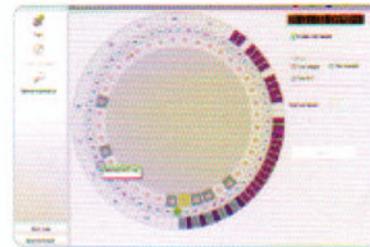

Automatic Alarm for Malfunctions

Automatic Washing Station

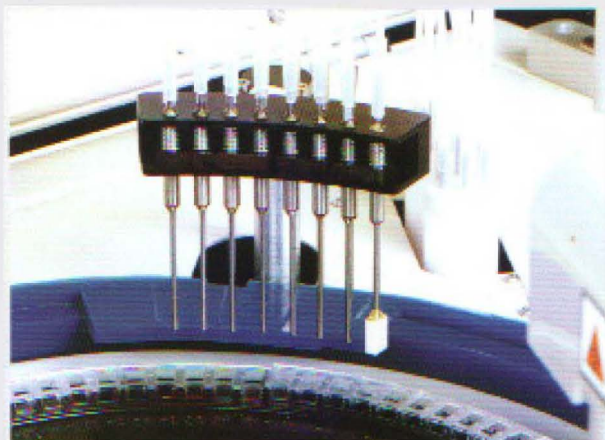

An 8-channel washing station ensures complete washing for cuvettes.

Environmental Protection Design

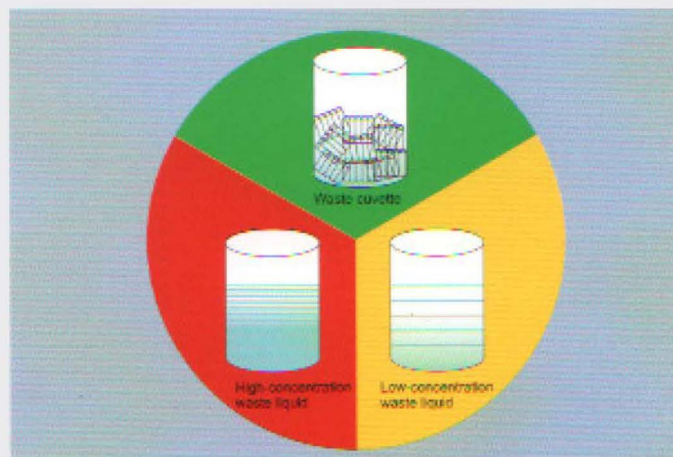

The waste is automatically classified and collected into different containers.

Automatic cuvette washing and blanking makes more precise results

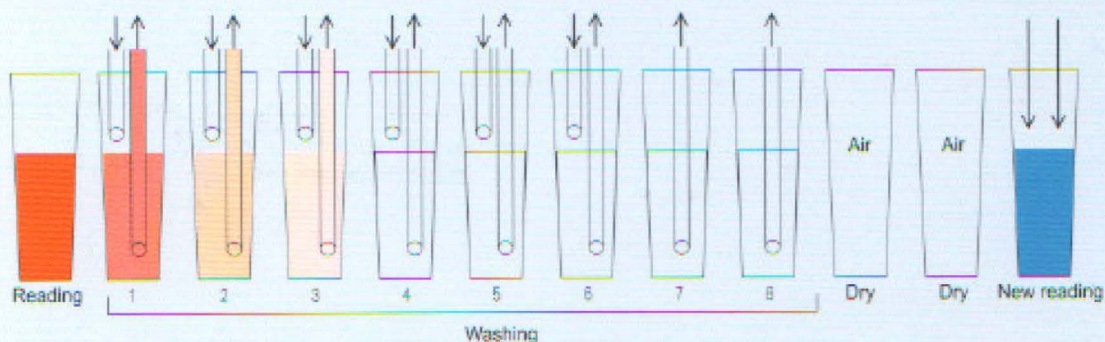

Wavelength	Reading	Wash1	Wash2	Wash3	Wash4	Wash5	Wash6	Wash7	Wash8	Dry	Dry	New reading
340nm	1.3100	0.025	0.0092	0.0037	0.0022	0.0008	0.0006	0.0005	0.0002	0.0800	0.0850	/
405nm	0.6920	0.0112	0.0075	0.0033	0.0019	0.0010	0.0005	0.0003	0.0002	0.0800	0.0805	/
450nm	0.5281	0.0108	0.0066	0.0031	0.0015	0.0009	0.0003	0.0003	0.0002	0.0806	0.0805	/
510nm	0.7005	0.0113	0.0055	0.0027	0.0012	0.0006	0.0002	0.0002	0.0001	0.0810	0.0811	/
546nm	0.5368	0.0184	0.0072	0.0043	0.0013	0.0008	0.0002	0.0002	0.0002	0.0840	0.0843	0.5090
578nm	0.0136	0.0135	0.0064	0.0031	0.0012	0.0006	0.0002	0.0002	0.0002	0.0800	0.0800	/
620nm	0.0189	0.0189	0.0054	0.0026	0.0010	0.0005	0.0002	0.0002	0.0002	0.0800	0.0800	/

Test O.D. value - Real reagent blank = True O.D. value

FACA-601-ISE Automatic Biochemistry Analyzer

More powerful software meets all needs.



- High throughput random access...
- 760 Tests/hour (including ISE)
- New style software, more friendly, efficient and convenient.
- Water-bath incubation technology ensures accurate reaction temperature.
- Frequency conversion technology makes movement more stable, reliable and lower noise.
- Perfect self-test and position auto-locating function minimize mechanical error.
- Auto stand-by function for saving energy consuming and 24 hours ready for work.
- Perfect Instrument-Reagent-Control/Calibrator system ensures the results with good traceability and coherence.



FACA-601-ISE Automatic Biochemistry Analyzer

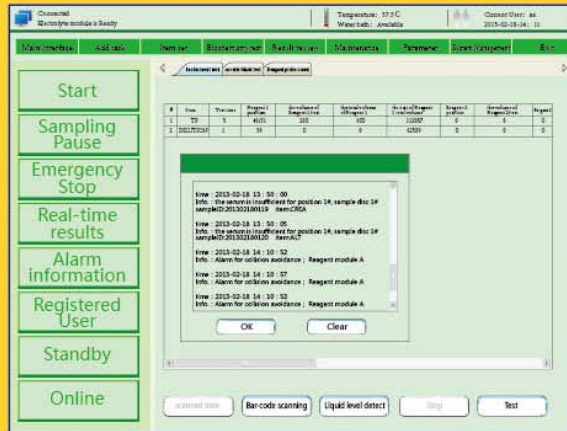

■ Smart warning and easy to correct function.

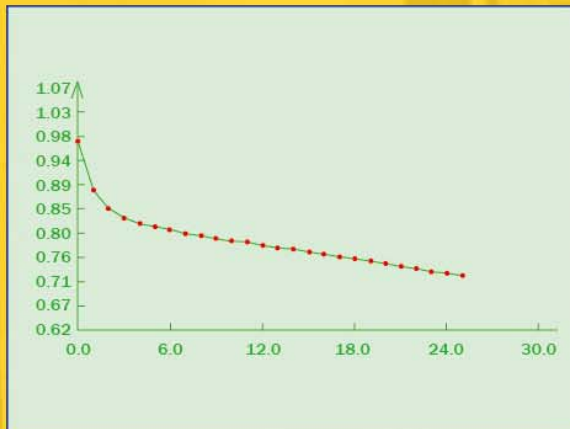

■ Reaction curve displaying on line and storing helps results analysis.

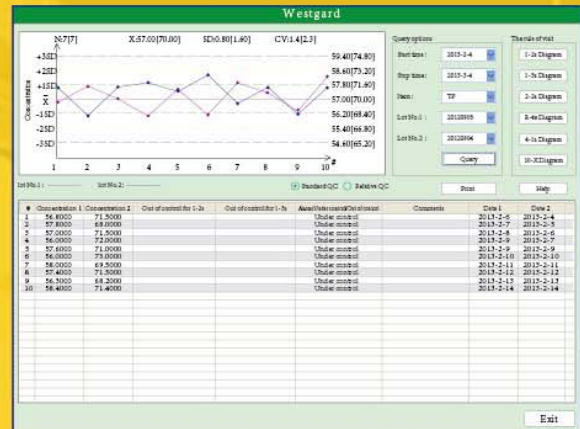

■ Levy jennings quality control program at multi-level.

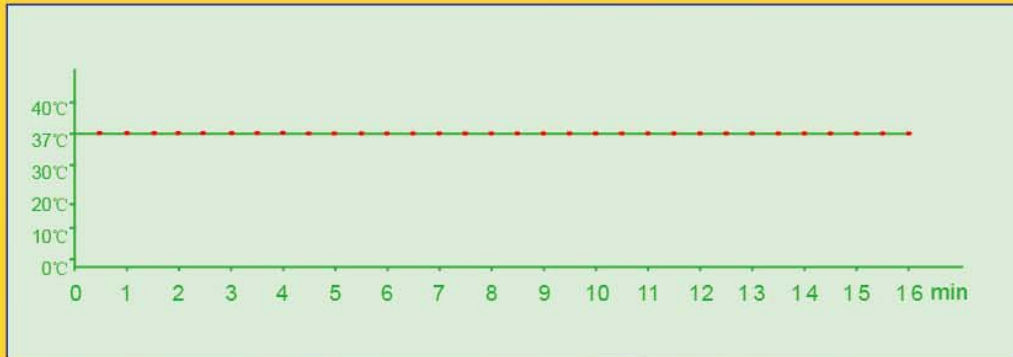

- Automatic high precision water-bath technology to ensure the temp. keeps at $37\pm 0.1^{\circ}\text{C}$ immediately and constantly.

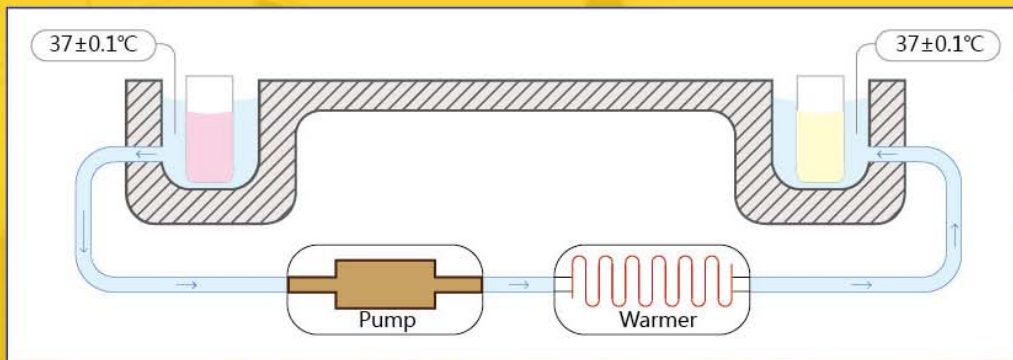

- Water-bath system.

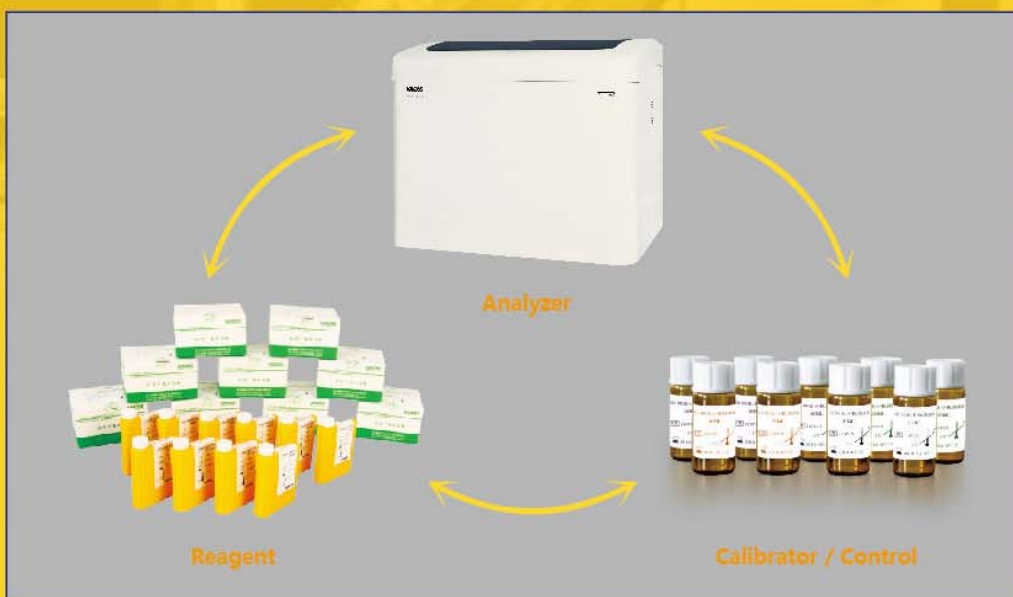

- Complete Instrument-Reagent-Control/Calibrator system guarantees traceability and reliability of all results.

FACA-601-ISE Automatic Biochemistry Analyzer



- ISE module is optional, test various ion items at the same time with accurate results and stable performance.

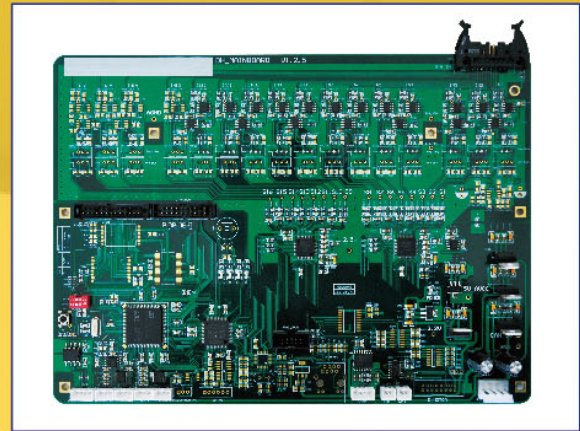

- Advanced high sensitive test technology.



- Eight channels washing station for each cuvette cleaning, automatic record and deduct cuvette blank value. Heavy washing function available for "dirt cuvette" to ensure each cuvette perfectly clean.



- High accuracy diluter, advanced sealed and connecting technology to guarantee accurate sampling.

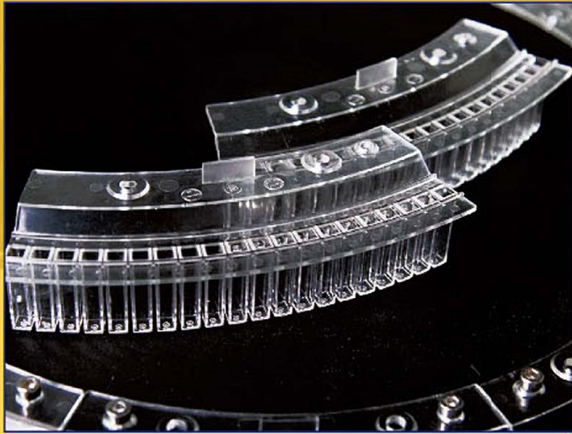

- High quality plastic cuvette.

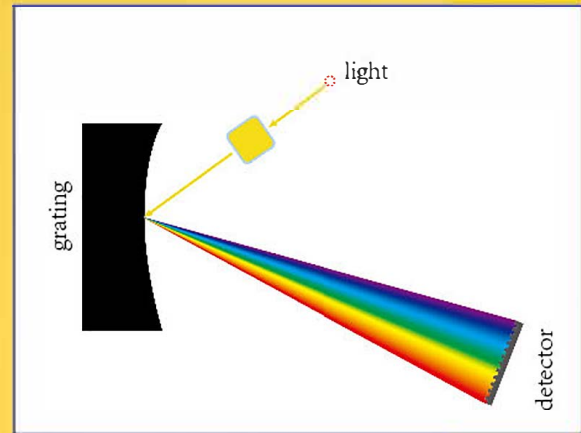

- High resolution concave grating system, wavelength range 340-800nm, multi-wavelength polychromatic assay at the same time.



- Two separate reagent chambers with independent refrigerators.

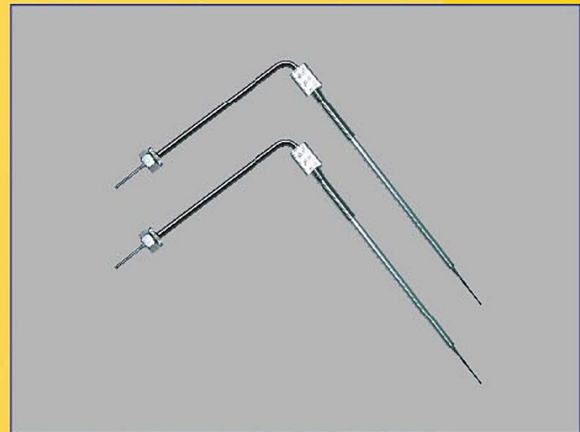

- Internal and external nano treated probe effectively reduce probe residual and carry over.

Technical Specifications

Model	FACA-601-ISE
Assay types	Random access
Throughput	760 T/hr(include ISE), 600 T/Hr(biochemical test only)
Analytical methods	End point, Kinetic(Rate), Fixed time, Single standard, Multi-standard, Single wavelength assay, Bichromatic, Bi-reagent assay, Serum blank assay, Immunoturbidimetric assay and ISE assay (KNa\Ca\C\NH)
Sample capacity	92 primary tube or micro serum cup
Sample/reagent probe	With liquid level sensor, automatically checking and tracking reagent allowance ability, internal and external nano treated, stereoscopic collision protection, plugging probe checking ability
Sample volume	1.0–100ul in 0.1 µl/step
Reagent volume	1–500ul in 0.1 µl/step
Reagent tray	2 reagent trays, barcode scanner available (on request), R3/R4 assay models available
Reagent refrigerator	2–8 °C, 24 hrs available
Reading Cuvette	160 cuvettes,made of ultraviolet transmittable plastic(or quartz glass cuvettes available on request)
Reaction volume	Minimum 120 µl
Reaction disc temp.	Water bath system, 37 ± 0.1°C,(air bath on request)
Cuvette cleaning	Automatical warm water washing station with 8 channels, blank reading for ensuring each cuvette well cleaned before using. Smart detergent clean for high contamination cuvette and probe, efficiently decreasing carry-over
Carry-over	Less than 0.05%
Monochromator	Concave grating
Wavelength range	340–810nm
Alarm	Automatic alarm for lack of reagent, sample , water, or waste filled and other errors, showing the info on monitor
Mixer	2 nano-surface treated mixing probers, with automatic warm water washing station for each one
Quality control	Multi-level QC for the same item automatically monitoring and alarming if the results out of control
Assay Linearity range	Wide linearity range measuring, also with automatically diluting function for high value sample
Calibration	Single or multi-points calibration, supporting linear and nonlinear assay
Data processing	Powerful software for calculating, blanking, multi-analysis, data reviewing, QC and results management,on line monitoring, editing etc.
Data storage	Long-term storage, storage capacity upon PC hard disc
Print	Multi report formats and user-self-defined report format are available
Power supply	AC 110V/60Hz or 220V/50Hz
Dimensions	1200mm x 900mm x 1100mm



LABOMED, INC.

All FACA Fully Automatic Biochemistry Analyzers have 2 different sample plates:
Standard sample plate for use with serum cup (serum order)



**STANDARD
SAMPLE
PLATE**

Test tube sample plate for use with 13x75 - 13x100mm test tubes (that is optional)



**TEST TUBE
SAMPLE
PLATE**

Labomed, Inc., Mailing Address: 2728 S La Cienega Blvd., Los Angeles, CA 90034 U.S.A.
TEL (310) 202-0811 FAX (310) 202-7286
Email: spectro@labomed.com, labomedinc@gmail.com